



## **3GHD-OE-2-SFP**

Dual SD/HD/3G-SDI optical to electrical converter  
with long haul optical SFP

## **User manual**

Rev. D

A large, solid green circular graphic with a white circular cutout in the center, located in the bottom right corner of the page.

**Nevion**  
Nordre Kullerød 1  
3241 Sandefjord  
Norway  
Tel: +47 33 48 99 99  
[nevion.com](http://nevion.com)

## Nevion Support

### Nevion Europe

P.O. Box 1020  
3204 Sandefjord, Norway  
Support phone 1: +47 33 48 99 97  
Support phone 2: +47 90 60 99 99

### Nevion USA

1600 Emerson Avenue  
Oxnard, CA 93033, USA  
Toll free North America: (866) 515-0811  
Outside North America: +1 (805) 247-8560

E-mail: [support@nevion.com](mailto:support@nevion.com)

See <http://www.nevion.com/support/> for service hours for customer support globally.

## Revision history

Current revision of this document is the uppermost in the table below.

Rev.	Repl.	Date	Sign	Change description
D	C	2015-09-29	AD	Optical connector corrected to SC/UPC
C	B	2015-03-26	AD	Figure 14: Fiber connections added
B	A	2014-09-01	MMI	Ready for product release
A	-	2014-06-20	AD	Initial document

---

## Contents

Revision history .....	2
1 Product overview .....	4
2 Specifications .....	5
2.1 General .....	5
2.2 Optical Inputs .....	5
2.3 Electrical Outputs .....	5
2.4 Standards.....	5
3 Configuration .....	6
3.1 Multicon Gyda configuration .....	6
3.2 Configuration through DIP settings.....	7
3.2.1 Re-clocker mode .....	8
3.2.2 Display optical input power.....	8
3.2.3 Automatic change over.....	9
3.2.4 Single converter configuration example.....	10
3.2.5 Dual converter configuration example .....	10
3.2.6 Dual converter with changeover configuration example.....	12
4 Connections .....	13
4.1 Mounting the connector module .....	13
4.2 Terminal format support .....	13
5 Operation.....	15
5.1 Module status.....	15
5.1.1 Multicon Gyda status interface .....	15
5.2 GPI ALARM – Module Status Outputs.....	16
5.2.1 GPI connections.....	16
5.3 Front panel – Status monitoring .....	16
General environmental requirements for Nevion equipment .....	18
Product Warranty.....	19
Appendix A Materials declaration and recycling information .....	20
A.1 Materials declaration.....	20
A.2 Recycling information.....	20

## 1 Product overview

The Flashlink 3GHD-OE-2-SFP is a dual multi bit-rate optical to electrical converter module providing high performance media conversion for various signal formats from 19.4Mbps up to 2970Mbps. Unmatched signal accuracy, even in critical applications with pathological signal patterns makes the 3GHD-OE-2-SFP the first choice for all optical transport demands.

The 3GHD-OE-2-SFP can transport all SD, HD and 3G signal formats in addition to DVB-ASI and SMPTE310M. It performs optical refreshing and signal re-clocking, which is selectable on application. The optical inputs are embedded in optional SFP module, which makes the module configurable to application specific needs. The open system platform of Nevion Flashlink system allows easy interoperability with third party fiber optical systems.

The 3GHD-OE-2-SFP unit has also three electrical outputs for each converter, which reduces the need for additional DA's.

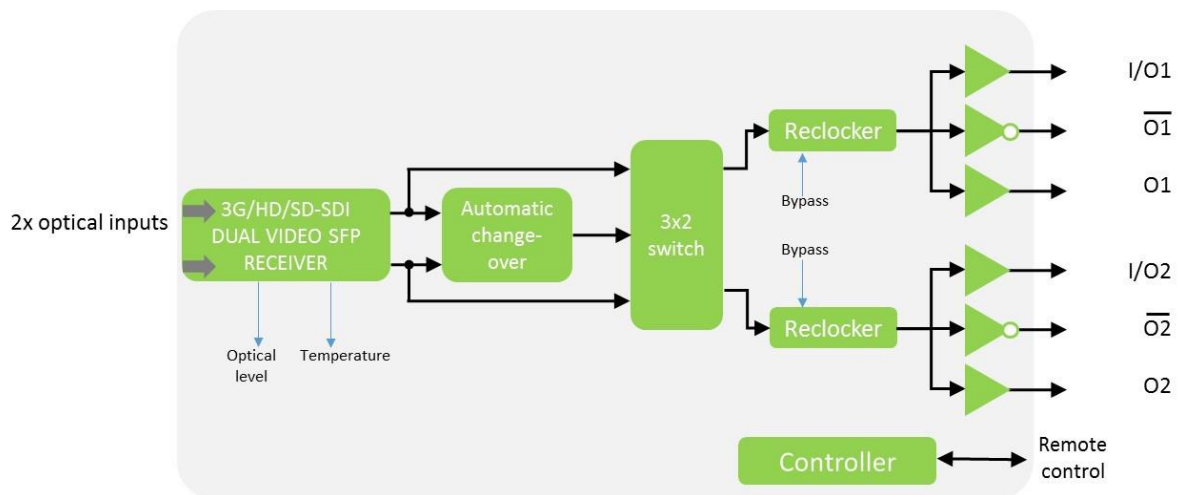

**Figure 1** Block diagram of the 3GHD-OE-2-SFP dual converter

## 2 Specifications

### 2.1 General

Power	+5V DC / 3.5W, max
Control	Control system for access to setup and module status with BITE (Built-In Test Equipment)
Temp. range	0 to +40 °C

### 2.2 Optical Inputs

Number of inputs	2
Transmission circuit fiber	Single mode 9/125um
Connector	SC/UPC, single mode
Optical wavelength	~1260-1620nm
Optical sensitivity	See manual for installed SFP
Optical overload	See manual for installed SFP
Detector damage threshold	See manual for installed SFP

### 2.3 Electrical Outputs

Number of outputs	6 (3 per converter)
Connector	BNC
Impedance	75 ohm
Return loss	>15dB @ 5-1485MHz >10dB 1485-2970MHz
Peak to peak signal level	800mV +/- 10%
Signal polarity	1 inverting, 2 non-inverting (per converter)

### 2.4 Standards

Supported standards for electrical and optical ports:

SMPTE292M, SMPTE259M, SMPTE297M, SMPTE305.2M, SMPTE310M, SMPTE424M, DVB-ASI EN50083-9.

### 3 Configuration

Configuration of this card can either be done from Multicon Gyda element manager or locally on the card by dipswitches.

#### 3.1 Multicon Gyda configuration

Below is a snapshot from the Multicon Gyda interface.

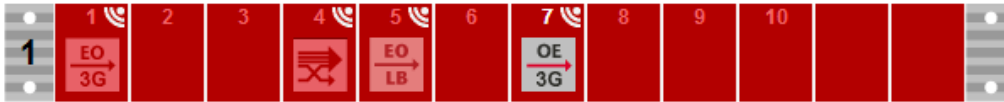

#### 3GHD SFP dual OE converter with CHO

Card label	<input type="text"/>	Locate card	<input type="text"/> sec	
Firmware upgrade	Upload file: <input type="text" value="None"/>	<input type="button" value="Upload"/>		
Output 1 selection	Main: <input checked="" type="radio"/> Optical input 1 <input type="radio"/> Optical input 2			
<b>Output selector</b>				
Input:	<input type="radio"/> Optical input 1	<input type="radio"/> Optical input 2	<input type="radio"/> Automatic selection	
Electrical output 1:	<input type="radio"/>	<input type="radio"/>	<input type="radio"/>	
Electrical output 2:	<input type="radio"/>	<input type="radio"/>	<input type="radio"/>	
Reclocker 1	<input type="radio"/> Enable <input checked="" type="radio"/> Bypass	Autobypass: <input type="radio"/> On <input checked="" type="radio"/> Off		
Reclocker 2	<input type="radio"/> Enable <input checked="" type="radio"/> Bypass	Autobypass: <input type="radio"/> On <input checked="" type="radio"/> Off		
<b>Alarm</b>	<b>Lower limit</b>	<b>Upper limit</b>	<b>Alarm</b>	<b>SNMP trap</b>
Output 1 selection			<input checked="" type="radio"/> Normal <input type="radio"/> Ignore	<input type="radio"/> Send <input checked="" type="radio"/> Ignore
Optical input 1			<input checked="" type="radio"/> Normal <input type="radio"/> Ignore	<input type="radio"/> Send <input checked="" type="radio"/> Ignore
Optical input 2			<input checked="" type="radio"/> Normal <input type="radio"/> Ignore	<input type="radio"/> Send <input checked="" type="radio"/> Ignore
Voltage (5.0V)	4500 mV	5500 mV	<input checked="" type="radio"/> Normal <input type="radio"/> Ignore	<input type="radio"/> Send <input checked="" type="radio"/> Ignore
Voltage (3.3V)	3000 mV	3600 mV	<input checked="" type="radio"/> Normal <input type="radio"/> Ignore	<input type="radio"/> Send <input checked="" type="radio"/> Ignore
Reclocker 1			<input checked="" type="radio"/> Normal <input type="radio"/> Ignore	<input type="radio"/> Send <input checked="" type="radio"/> Ignore
Reclocker 2			<input checked="" type="radio"/> Normal <input type="radio"/> Ignore	<input type="radio"/> Send <input checked="" type="radio"/> Ignore
<b>Card version</b>				
hw	1.1			
lib	1.2.2			
serial	2208807460200336			
sfp	23182			
sw	1.1.18			

Figure 2 Configuration tab

### 3.2 Configuration through DIP settings

The 3GHD-OE-2-SFP can support a number of different broadcast formats. The correct configuration can either be set with the two Dipswitches on the card or through the GYDA Control System. The layout is shown in the drawing below with the DIP switches to the upper left position.

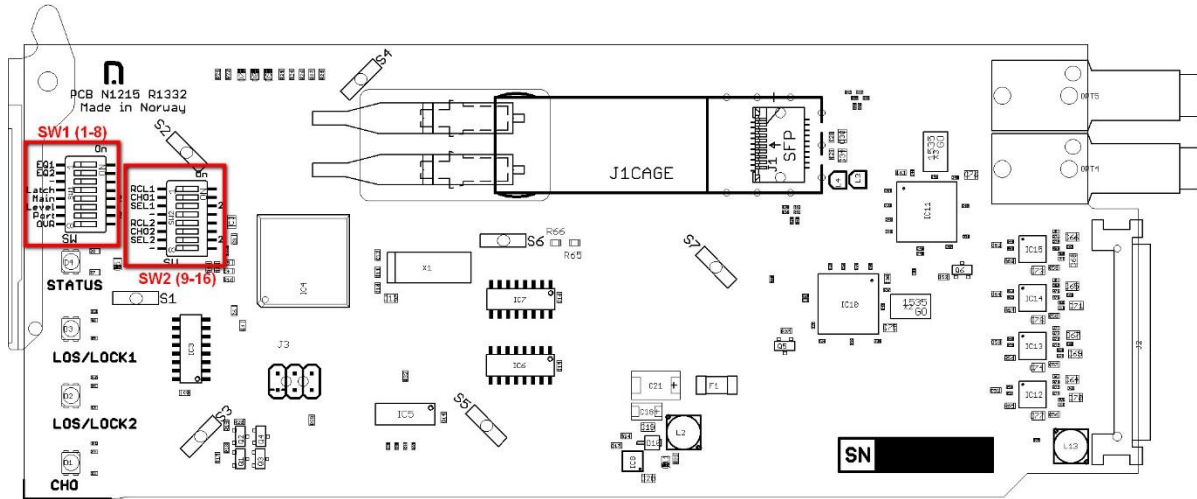

Figure 3 3GHD-OE-2-SFP board layout

Table 1: DIP settings.

Switch #	Label	Function, DIP=OFF	Function, DIP=ON	Comment
1	EQ1			Not used
2	EQ2			Not used
3				Not used
4	Latch	Latched	Non-latched	Select if changeover is latched or non-latched
5	Main	Optical input 1 is main	Optical input 2 is main	Select's main input to changeover
6	Level	LED's normal operation	All LED's showing optical input power	DOP See Table 2 Displaying optical input power
7	Port	Optical input 1	Optical input 2	Selects which optical input to be used for dip 7/DOP
8	OVR	GYDA control. Configuration with GYDA	Override GYDA control. Configuration with DIP switch	Select configuration from GYDA
9	RCL1	Reclocker 1 bypass	Reclocker 1 enabled	Sets reclocker mode for output 1
10	CHO1	Change over disabled	Change over enabled	Enables change over for output 1
11	SEL1	Optical input 1	Optical input 2	This setting are overridden if DIP 10 (CHO1) is enabled
12				Not used

13	RCL2	Reclocker 2 bypass	Reclocker 2 enabled	Sets reclocker mode for output 2
14	CHO2	Change over disabled	Change over enabled	Enables change over for output 2
15	SEL2	Optical input 1	Optical input 2	This setting are overridden if DIP 14 (CHO2) is enabled
16				Not used

All DIP switches are off when pointing towards the release handle.

### 3.2.1 Re-clocker mode

The re-clocker can be set to re-clock or bypass from DIP#9 and DIP#13 or from GYDA.

When re-clocker is set to re-clock mode jitter from signal is removed. Accepted bitrates is 270, 1483.5, 1485, 2967 and 2970Mbps.

When re-clocker is set to bypass the converter accepts all bitrates between 2 to 2970Mbps. Note that in this mode the jitter is not removed and this can cause problems for equipment following the converter.

#### 3.2.1.1 Transparency

This converter only looks at the bitrates and not the content. This means that any signal with correct bitrates is converted. The product is transparent to data in the ancillary space like embedded audio.

### 3.2.2 Display optical input power

The LED's can be used as an optical power meter. This is practical under installation of the module. The power measurement is not accurate but can be used as an indication of optical power strength. Remember to turn this function of after installation. When all LEDs are green the optical input power is more than -6.5dBm. When all LEDs are off input power is below -25dBm.

The DOP (Display of Optical input Power) can only be turned on from the DIP. DOP is turned on by DIP#6.



Table 2 Displaying optical input power

Optical input power	Status LED	LOS/lock1 LED	LOS/lock2 LED	
More than -6.5dBm	Green	Green	Green	Green
-7.0dBm to -8.5dBm	Yellow	Green	Green	Green
-9.0dBm to -10.5dBm	Red	Green	Green	Green
-11.0dBm to -12.5dBm		Green	Green	Green
-13.0dBm to -14.5dBm		Yellow	Green	Green
-15.0dBm to -16.5dBm		Red	Green	Green
-17.0dBm to -18.0dBm			Green	Green
-18.5dBm to -19.0dBm			Yellow	Green
-19.5dBm to -20.0dBm			Red	Green
-21.0dBm to -22.0dBm				Green
-23.0dBm to -24.0dBm				Yellow
Below -25dBm				Red

### 3.2.3 Automatic change over

Dual optical converter has an automatic change over module. This module has the possibility to have an automatic change over on the input. This can be used in redundancy systems where the user wants automatically switch to a backup port when the main input loses signal. This function can be selected with DIP#10 and Dip#14. Each converter can be configured to be main and backup input by DIP#5 or from GYDA.

#### 3.2.3.1 Trigger condition

Loss of optical power trigs the automatic change over. When the main input lose optical power the backup input is selected. When the backup input is active an alarm is displayed in GYDA. When the main input optical power is restored the converter switches immediately back to main input and alarm is restored.

Note that bit error or loss of lock on re-clocker does not trigger the automatic change over.

### 3.2.4 Single converter configuration example

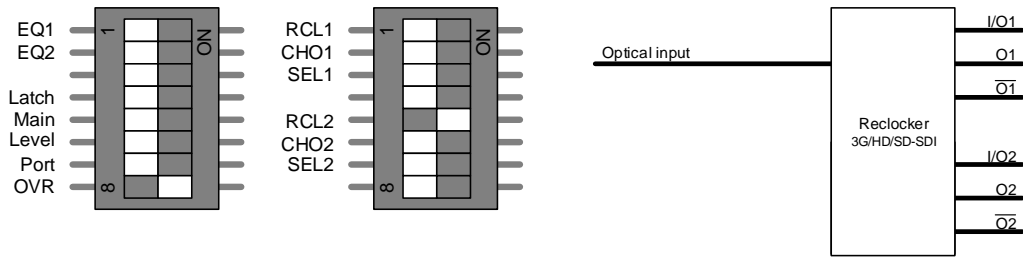

Figure 4 Single OE converter with reclocker

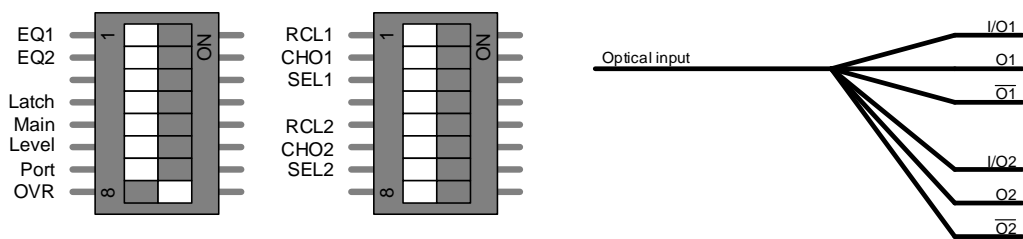

Figure 5 Single OE converter with reclocker in bypass

### 3.2.5 Dual converter configuration example

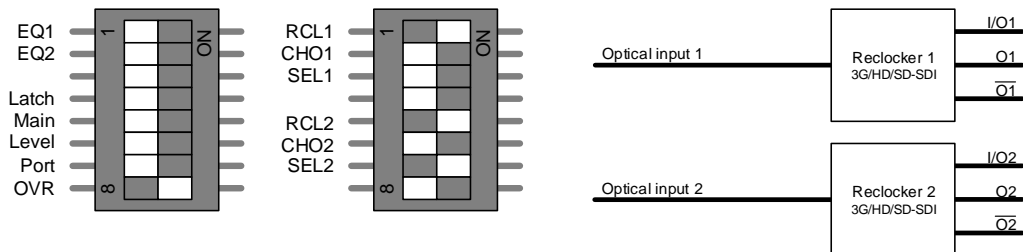

Figure 6 Dual OE converter, standard setup

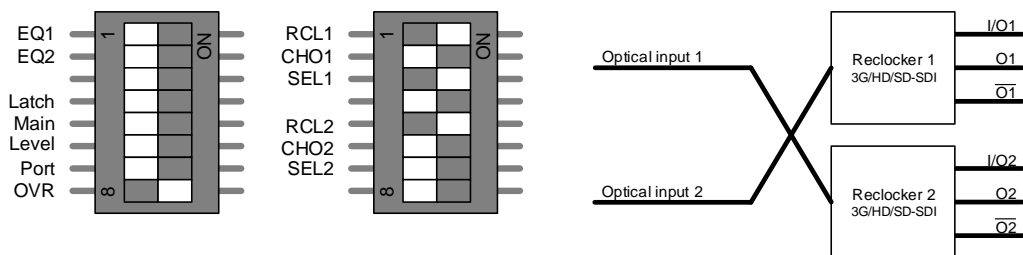

Figure 7 Dual OE converter, input swap

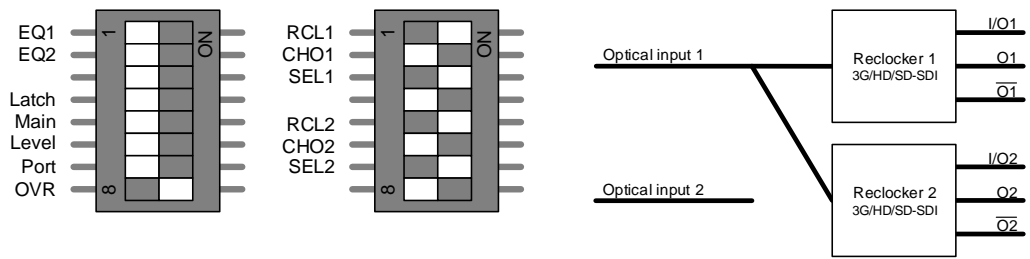

Figure 8 Dual OE converter with DA, input 1

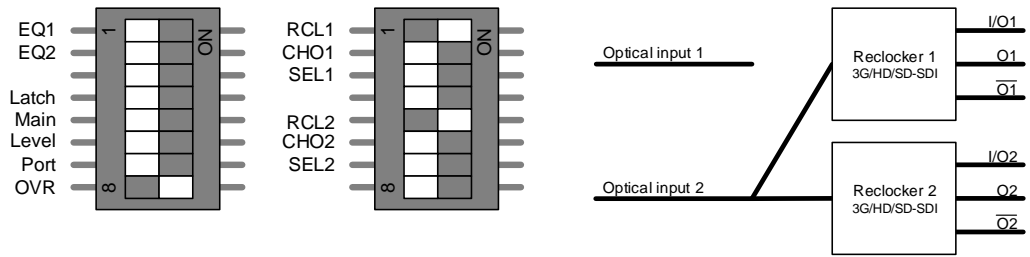

Figure 9 Dual OE converter with DA, input 2

### 3.2.6 Dual converter with changeover configuration example

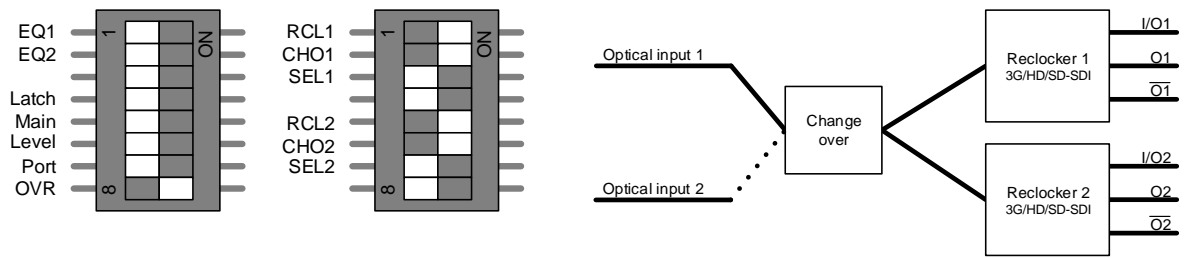

Figure 10 Changeover on all output, optical 1 as main

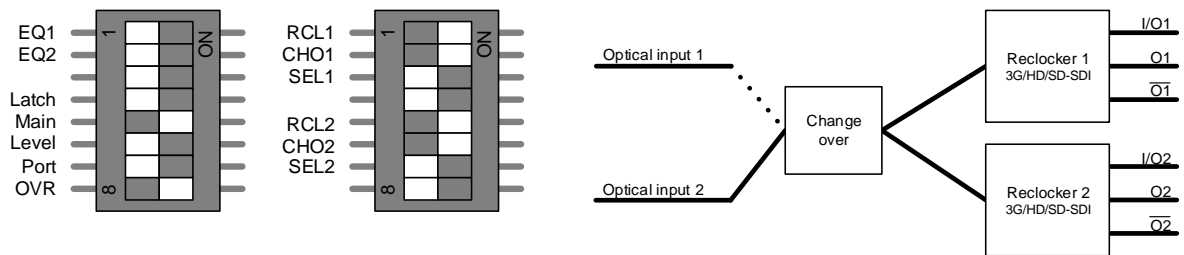

Figure 11 Changeover on all output, optical 2 as main

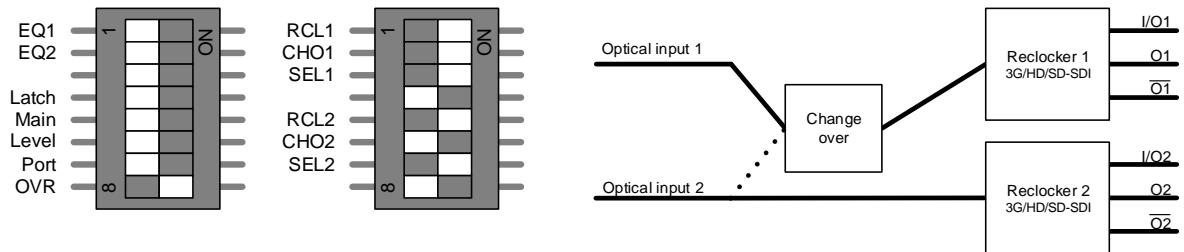

Figure 12 Changeover on output 1, optical 1 as main. Optical 2 on output 2

## 4 Connections

The 3GHD-OE-2-SFP has a dedicated connector module; 3GHD-EO-2-C1. This module is mounted at the rear of the sub-rack. The layout of the module is shown in the figure below.

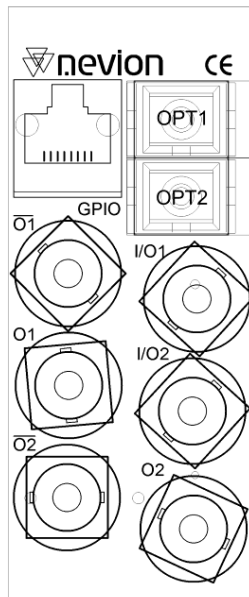

Figure 13 Connector module for 3GHD-OE-L-2-SFP

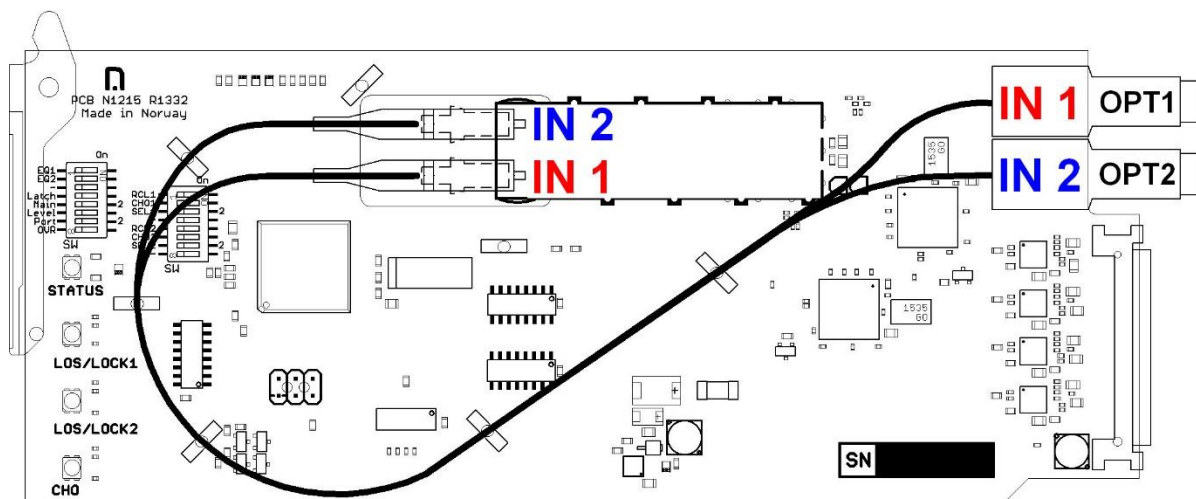

Figure 14: Fiber connections

### 4.1 Mounting the connector module

The details of how the connector module is mounted, is found in the user manual for the sub-rack frame FR-2RU-10-2.

This manual is also available from our web site: <http://www.nevion.com>

### 4.2 Terminal format support

The different input and output ports on 3GHD-OE-2-SFP can support a number of formats. The table below show which signal formats are supported on the selected terminals.

Unused inputs should be terminated to avoid alarms triggered by noise.

Table 3 Signal support

Terminal	Function	Supported Format	Mode
OPT1 OPT2	Optical input	SDI, DVB-ASI, SMPTE310, Transparent	Input
I/O1 I/O2 O1 O2	Electrical Output Reclocked DA output	SDI, DVB-ASI, Transparent	Output
$\overline{O1}$ $\overline{O2}$	Electrical Output Reclocked DA inverted output	SDI, Transparent	Output
GPI ALARM	Open Collector Alarms	Wired alarms	OC Output

## 5 Operation

### 5.1 Module status

The status of the module can be monitored in three ways.

1. GYDA System Controller (optional).
2. GPI at the rear of the sub-rack.
3. LED's at the front of the sub-rack.

Of these three, the GPI and the LED's are mounted on the module itself, whereas the GYDA System Controller is a separate module giving detailed information on the card status.

#### 5.1.1 Multicon Gyda status interface



#### 3GHD SFP dual OE converter with CHO

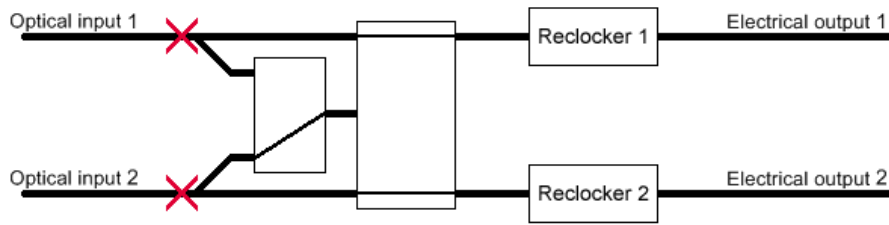

Optical input 1	Loss of signal
Optical input 2	Loss of signal
Voltage (5.0V)	5.00 V
Voltage (3.3V)	3.29 V
Reclocker 1	Bypass
Reclocker 2	Bypass
SFP Temp	50.4 C

Alarms		
Output 1 selection	ACKNOWLEDGED	
Optical input 1	ACKNOWLEDGED	
Optical input 2	ACKNOWLEDGED	

Figure 15 Dual converter status tab

The on-board temperature measurement is a feature used for monitoring variations in temperature over time and can be accessed thru SNMP. The absolute value of the temperature measurement has little value of its own as it does not reflect the temperature inside the electronics nor the ambient frame temperature.

## 5.2 GPI ALARM – Module Status Outputs

These outputs can be used for wiring up alarms for third party control systems. The GPI outputs are open collector outputs, sinking to ground when activated. The GPI connector is shown in figures below.

### Electrical maximums for GPI outputs:

Max current: 100mA

Max voltage: 30V

### 5.2.1 GPI connections

3GHD-EO-SFP module GPI pinning:

Signal	Name	Pin #	Mode
Status	General error status for the module.	Pin 1	Open Collector This is normally closed.
LOS1	Loss of signal on input 1.	Pin 2	Open Collector
LOS2	Loss of signal on input 2. Only for dual converter	Pin 3	Open Collector
Ground	0V / gnd pin.	Pin 8	0V.

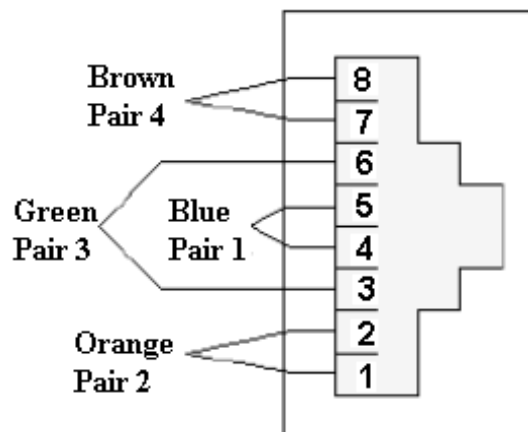
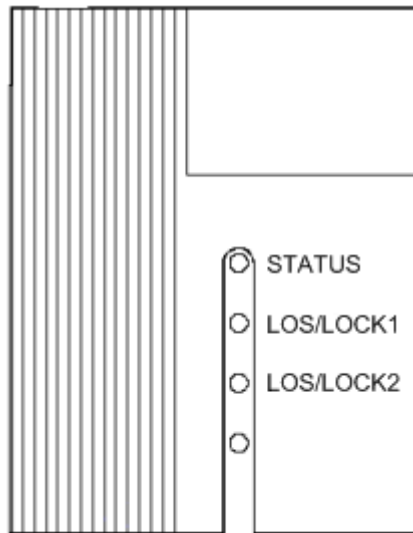

Figure 16 GPI connector

## 5.3 Front panel – Status monitoring

The status of the module can be easily monitored visually by the LED's at the front of the module. The LED's are visible through the front panel as shown in the figure below.





**Figure 17 Front panel LED's**

The 3GHD-OE-2-SFP has 3 LED's each showing a status corresponding to the GPI pinning. When DIP#3 is on the LED's are used as an optical power meter.

**Table 4 Front panel LED's**

Diode \ State	Red LED	Yellow LED	Green LED	No light
Status	Module is faulty, or module is initializing.	N/A	Module is OK Module power is OK	Module has no power
LOS/LOCK1	No input signal on electrical output 1.	Input signal on electrical output 1 but reclocker not in lock.	Input signal on electrical output 1 and reclocker in lock.	
LOS/LOCK2	No input signal on electrical output 2.	Input signal on electrical output 1 but reclocker not in lock.	Input signal on electrical output 1 and reclocker in lock.	

## **General environmental requirements for Nevion equipment**

1. The equipment will meet the guaranteed performance specification under the following environmental conditions:
  - Operating room temperature range: 0°C to 45°C
  - Operating relative humidity range: <90% (non-condensing)
  
2. The equipment will operate without damage under the following environmental conditions:
  - Temperature range: -10°C to 55°C
  - Relative humidity range: <95% (non-condensing)

## **Product Warranty**

The warranty terms and conditions for the product(s) covered by this manual follow the General Sales Conditions by Nevion, which are available on the company web site:

[www.nevion.com](http://www.nevion.com)

## Appendix A Materials declaration and recycling information

### A.1 Materials declaration

For product sold into China after 1st March 2007, we comply with the “Administrative Measure on the Control of Pollution by Electronic Information Products”. In the first stage of this legislation, content of six hazardous materials has to be declared. The table below shows the required information.

組成名稱 Part Name	Toxic or hazardous substances and elements					
	鉛 Lead (Pb)	汞 Mercury (Hg)	鎘 Cadmium (Cd)	六价铬 Hexavalent Chromium (Cr(VI))	多溴联苯 Polybrominated biphenyls (PBB)	多溴二苯醚 Polybrominated diphenyl ethers (PBDE)
3GHD-OE-2-SFP	○	○	○	○	○	○

O: Indicates that this toxic or hazardous substance contained in all of the homogeneous materials for this part is below the limit requirement in SJ/T11363-2006.

X: Indicates that this toxic or hazardous substance contained in at least one of the homogeneous materials used for this part is above the limit requirement in SJ/T11363-2006.

This is indicated by the product marking:



### A.2 Recycling information

Nevion provides assistance to customers and recyclers through our web site <http://www.nevion.com/>. Please contact Nevion’s Customer Support for assistance with recycling if this site does not show the information you require.

Where it is not possible to return the product to Nevion or its agents for recycling, the following general information may be of assistance:

- Before attempting disassembly, ensure the product is completely disconnected from power and signal connections.
- All major parts are marked or labeled to show their material content.
- Depending on the date of manufacture, this product may contain lead in solder.
- Some circuit boards may contain battery-backed memory devices.