



DA-3GHD-2x4

Multi Rate 3GHD-SDI Distribution Amplifier

User manual

Rev. C

A large green circular graphic with a white center, partially visible in the bottom right corner of the page.

Nevion
Nordre Kullerød 1
3241 Sandefjord
Norway
Tel: +47 33 48 99 99
nevision.com

Nevion Support

Nevion Europe

P.O. Box 1020
3204 Sandefjord, Norway
Support phone 1: +47 33 48 99 97
Support phone 2: +47 90 60 99 99

Nevion USA

1600 Emerson Avenue
Oxnard, CA 93033, USA
Toll free North America: (866) 515-0811
Outside North America: +1 (805) 247-8560

E-mail: support@nevision.com

See <http://www.nevision.com/support/> for service hours for customer support globally.

Revision history

Current revision of this document is the uppermost in the table below.

Rev.	Repl.	Date	Sign	Change description
C	2	2015-05-15	MB	Cover page update; DoC removed; no other changes to content
2	1	2012-11-19	RB	Specifications for electrical outputs: <ul style="list-style-type: none"> - Added note regarding output signal level when using passive bypass versions. Specifications for electrical inputs: <ul style="list-style-type: none"> - Divided the cable equalization @2970Mbps into 2 classes; with and without relays for passive bypass. Product overview: <ul style="list-style-type: none"> - Added comment of 60 meters of cable equalizing for 2970Mbps with the passive bypass versions.
1	0	2012-09-27	MR/RB	Changes in Table 4 - Description of GPI interface: <ul style="list-style-type: none"> - Changed to "Not used" for pin 2, 5 and 6. - Changed to focus on outputs rather than inputs for signal present. - All outputs are inverted open collector and open is alarm. Changes in Figure 9: Panel indicator overview: <ul style="list-style-type: none"> - "Main/Bypass" changed to "Not used" for LED 4 Changes to chapter 1 Product overview: <ul style="list-style-type: none"> - Removed reference to change-over. - Added description of distribution of the two inputs to various outputs.
0	A	2011-01-31	MR	Initial version

Contents

Revision history 2

1 Product overview 4

2 Specifications 6

3 Configuration 7

3.1 Configuration Examples..... 8

4 Connections 9

5 Operation 11

General environmental requirements for Nevion equipment 13

Product Warranty 14

Appendix A Materials declaration and recycling information 15

A.1 Materials declaration 15

A.2 Recycling information 15

1 Product overview

The Flashlink DA-3GHD-2x4 is a multi bit-rate distribution amplifier module providing high performance media distribution for various signal formats from 19.4Mbps up to 2970Mbps. The unit can be configured to do cable equalizing and reclocking of SMPTE 424M, SMPTE 292M and SMPTE 259M signal formats.

The two inputs typically provide automatic cable equalizing for up to 70 meters (60 meters for the passive bypass versions) of cable (Belden 1694A at 2970Mbps) with a total of 6 or 8 reclocked outputs. The DA-3GHD-2x4 will detect HD and SD rates and automatically switch to the correct output slew-rate.

The reclockers support the bit-rates 270Mbps, 1483.5Mbps, 1485Mbps 2967Mbps and 2970Mbps. For other rates, the reclockers automatically switch to bypass mode, and the DA-3GHD-2x4 will work as a non-reclocking distribution amplifier with cable equalizers.

The DA-3GHD-2x4 also supports reclocking of DVB-ASI at 270Mbps, enabling all possible rates including empty transport streams with only K28.5 padding packets. 4 of the outputs are non-inverting and suitable for DVB-ASI.

The unit has two 1x4/3 distribution amplifiers that can be individually configured to listen on either input, giving 4 different options, input 1 to all outputs, input 2 to all outputs, inputs 1 to first group with 2 on second group, or input 2 to first group and 1 to second group.

There is also included a passive bypass function (with backplane board C2 and C4) from both inputs to non-inverted outputs with less than 15 m loss of cable length (enables full redundancy in case of mains failure).

The DA-3GHD-2x4 is designed for all distribution purposes in studio, duplication and broadcast applications.

The DA-3GHD-2x4 main board can be combined with 4 different backplane boards giving functions as follows:

Product	Type of backplane board	# Outputs	GPI I/O	Relay (passive loop-through)
19240 DA-3GHD-2x4	Version C1	8	No	No
19241 DA-3GHD-2x4-PB	Version C2	8	No	Yes
19242 DA-3GHD-2x3-G	Version C3	6	Yes	No
19243 DA-3GHD-2x3-PB-G	Version C4	6	Yes	Yes

Table 1: Product overview

Please observe that –G versions cannot be used with N-Box, Flashlink one module desktop box, due to mechanical issues.

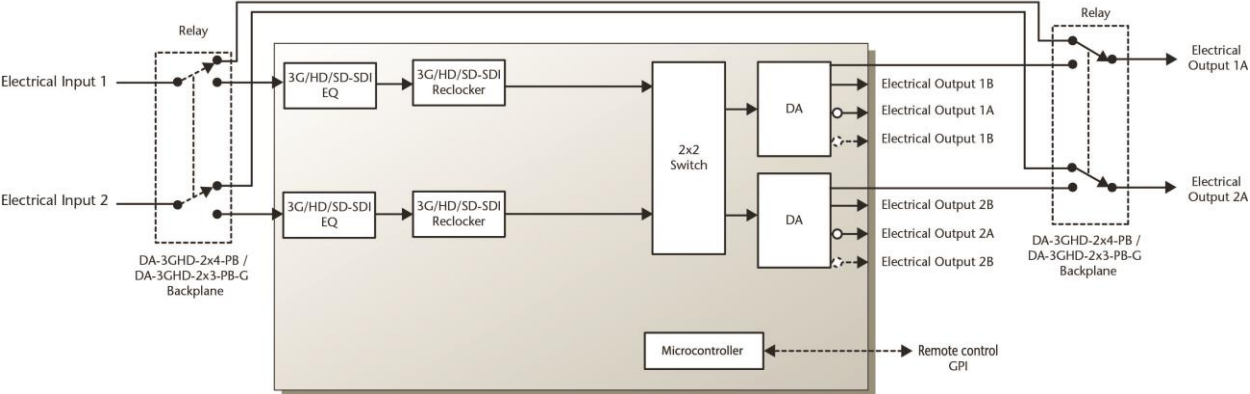

Figure 1: DA-3GHD-2x4 block diagram

2 Specifications

Electrical Outputs

Connectors	75 Ohm BNC
Output Return loss	- < -15dB, 5MHz -1.5GHz - < -10dB, 1.5GHz - 3GHz
Output signal level	800mV +/- 10% Note: for the passive bypass versions (using backplane C2 or C4) the signal is attenuated with a cable equivalent of 15m.
Output signal rise / fall time 20% - 80%	- SD limit: [0.4ns – 1.5ns]; <0.5ns rise/fall var. - HD limit: < 270ps, <100ps rise/fall var. - 3G HD limit: <135ps, <50ps rise/fall var.
Amplitude overshoot	<10%
Polarity	- Output O1A, O1B, O2A and O2B: Non inverting electrical - Remaining outputs: inverting electrical
Output timing jitter	- SD: <0.2 UI - HD: <1 UI - 3G HD: <1UI
Output alignment jitter	- SD: <0.15 UI - HD: <0.15 UI - 3G HD: <0.2UI

Electrical Inputs

Connectors	75 Ohm BNC
Input Cable Eq. @270Mbps	>300m w/Belden 1694A, with BER < 10E-12
Input Cable Eq. @1485Mbps	>100m w/Belden 1694A, with BER < 10E-12
Input Cable Eq. @2970Mbps	Ver. C1 and C3: >70m w/Belden 1694A, with BER < 10E-12 Ver. C2 and C4: >60m w/Belden 1694A, with BER < 10E-12
Input Return loss	- < -15dB, 5MHz -1.5GHz - < -10dB, 1.5GHz - 3GHz
Jitter tolerance	- SD limit: - 10Hz-1kHz: >1 UI - 10kHz – 5MHz: >0.2 UI - HD limit: - 10Hz-100kHz: >1 UI - 100kHz–10MHz: >0.2 UI - 3G HD limit: - 10Hz-100kHz: >2 UI - 100kHz–10MHz: >0.3 UI

Features

Reclocking:	Automatic SD/ HD detection Automatic output slew rate adjustment according to SMPTE 259M and SMPTE 292M / SMPTE 424M
Supported clock rates:	270, 1483.5, 1485, 2967, 2970Mbps
Input equalizers:	Eq. bypass for non-video formats or low bit rates

Supported standards

SMPTE:	SMPTE 424M, SMPTE 292M, SMPTE 259M, SMPTE 305M, SMPTE 310M
DVB-ASI:	EN50083-9 (on non-inverting outputs)

General

DC power consumption:	+5V / < 4.5W
-----------------------	--------------

3 Configuration

The DA-3GHD-2x4 supports a number of different formats. The correct configuration can either be set with a DIP switch or with the GYDA system controller. The layout of DA-3GHD-2x4 is shown in the drawing below with the DIP switch to the upper left position.

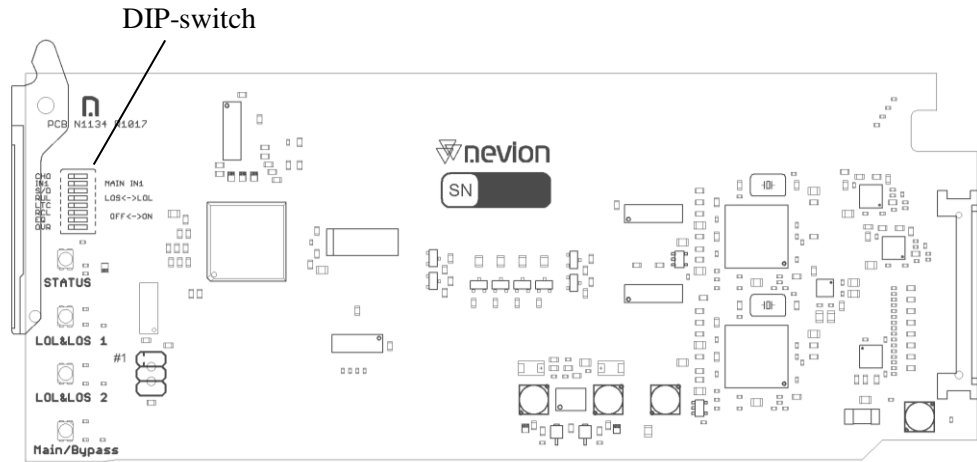

Figure 2: DA-3GHD-2x4 module DIP switches

DIP switch configuration must be set according to the table below:

Switch #	Label	Function DIP=OFF	Function DIP=ON	Comment
1	CHO			Not used
2	IN1	Input 1 stby, 2 main	Input 1 main, 2 stby	Select main/standby
3	S/D	Single distributed output	Dual distributed output	Single or dual distribution amplifier
4	RUL			Not used
5	LTC			Not used
6	RCL	Reclocker Bypass	Reclocker ON	Reclocker mode
7	EQ	Cable equalizer Bypass (Loss of signal will not work on this mode)	Cable equalizer ON	Equalizer mode
8	OVR	Module controlled by Gyda system controller	Module controlled by DIP switches	Select GYDA config. mode

Table 2: DA-3GHD DIP switches

All DIP switches are off when pointing towards the release handle.

3.1 Configuration Examples

Typical configurations for DA-3GHD-2x4:

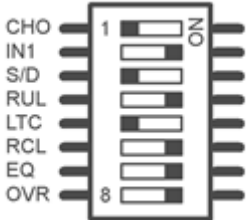

Figure 3: Distribution mode, Input 1 priority, Input 1 to all outputs, reclocker and equalizer on

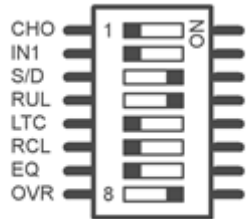

Figure 4: Distribution mode, Input 2 priority, Input 1 to 4 outputs, Input 2 to 4 outputs, transparent mode without equalization and reclocking.

4 Connections

The DA-3GHD-2x4 has four dedicated back planes: DA-3GHD-2x4-C1, -C2, -C3 and -C4. These modules are mounted at the rear of the sub-rack. The modules are shown in Figure 5 to Figure 8.

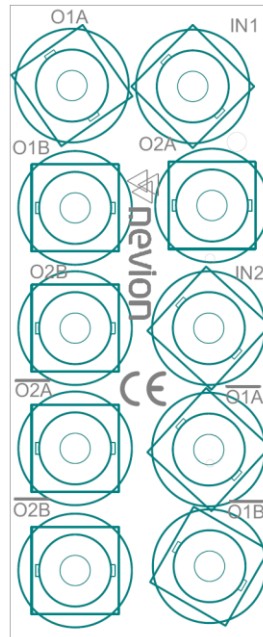

Figure 5: Overview of the DA-3GHD-2x4-C1 connector module

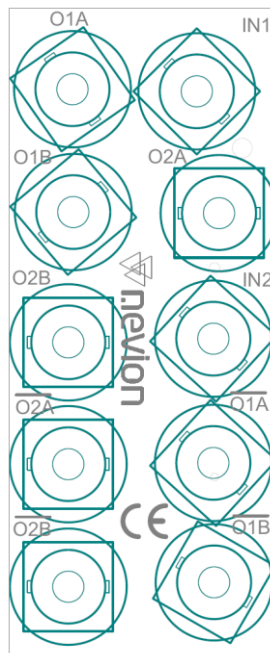

Figure 6: Overview of the DA-3GHD-2x4-C2 connector module

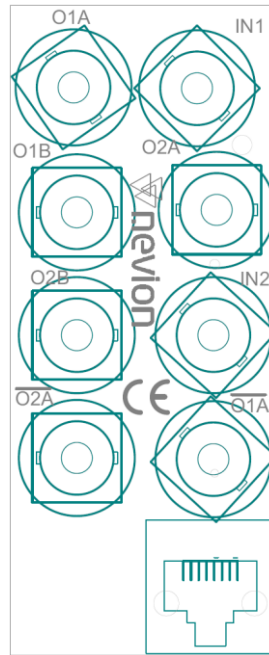

Figure 7: Overview of the DA-3GHD-2x4-C3 connector module

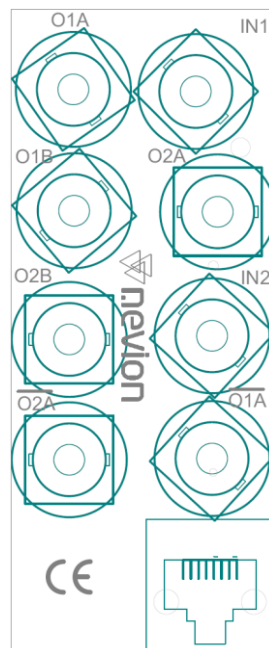

Figure 8: Overview of the DA-3GHD-2x4-C4 connector module

The electrical input signals are connected to the *IN1* and *IN2* BNCs and the electrical outputs are connected to the *O--* BNCs.

Please note that $\overline{O1A}$, $\overline{O1B}$, $\overline{O2A}$ and $\overline{O2B}$ have inverted signals. DVB-ASI cannot be used on these outputs .

Unused inputs and outputs should be terminated with 75 ohm to meet the specifications.

5 Operation

The status of the module can be easily monitored visually by the LEDs at the front of the module. The LEDs are visible through the front panel as shown below.

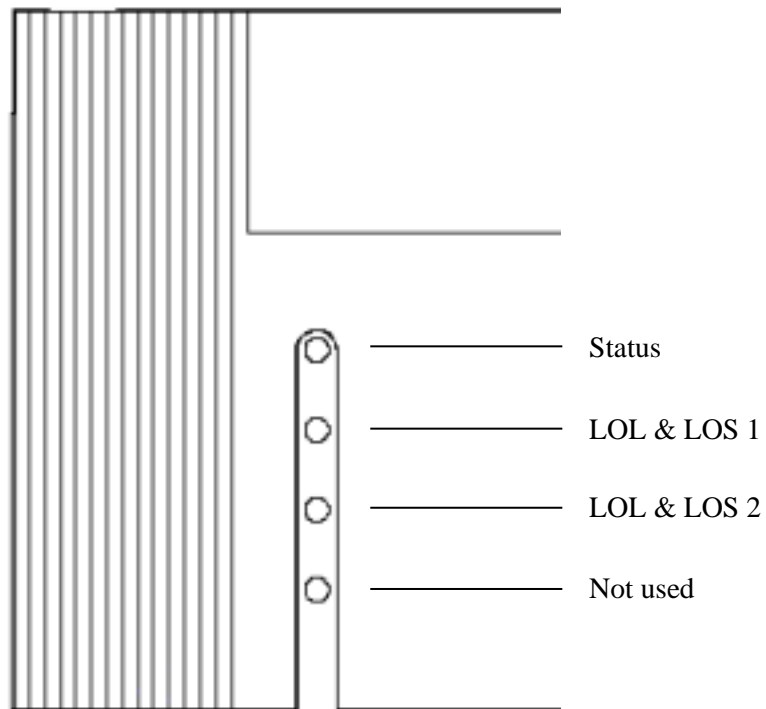

Figure 9: Panel indicator overview (Text not printed on the front panel)

The functions of the different LEDs are described in table below:

Diode \ state	Red LED	Yellow LED	Green LED	No light
Status	Module is faulty		Module is OK Module has power	Module has no power
LOL & LOS 1 (Input 1)	No Reclocker Lock & Loss Of Signal	No Reclocker lock & Signal present	Reclocker in lock & Signal present	
LOL & LOS 2 (Input 2)	No Reclocker Lock & Loss Of Signal	No Reclocker lock & Signal present	Reclocker in lock & Signal present	
Fourth LED not used				

Table 3: LED status description

GPI name (setup1/ setup2)	Function (setup1/ setup2)	Pin #	Mode	Direction	Electrical Maximums for GPI outputs:
Status	General error status for the module.	Pin 1	Inverted Open Collector (open is alarm)	Output	Max current: 100mA Max voltage: 30V Max power: 200mW
Not used		Pin 2			
Signal present 1	Good signal routed to output 1	Pin 3	Inverted Open Collector (open is alarm)	Output	
Signal present 2	Good signal routed to output 2	Pin 4	Inverted Open Collector (open is alarm)	Output	
Not used		Pin 5			
Not used		Pin 6			
Not used		Pin 7			
Ground	0 volt pin	Pin 8	0V.		

Table 4: Description of GPI interface

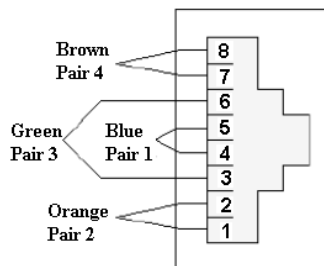

Figure 10: GPI Interface

General environmental requirements for Nevion equipment

1. The equipment will meet the guaranteed performance specification under the following environmental conditions:
 - Operating room temperature range: 0°C to 45°C
 - Operating relative humidity range: <90% (non-condensing)

2. The equipment will operate without damage under the following environmental conditions:
 - Temperature range: -10°C to 55°C
 - Relative humidity range: <95% (non-condensing)

Product Warranty

The warranty terms and conditions for the product(s) covered by this manual follow the General Sales Conditions by Nevion, which are available on the company web site:

www.nevion.com

Appendix A Materials declaration and recycling information

A.1 Materials declaration

For product sold into China after 1st March 2007, we comply with the “Administrative Measure on the Control of Pollution by Electronic Information Products”. In the first stage of this legislation, content of six hazardous materials has to be declared. The table below shows the required information.

組成名稱 Part Name	Toxic or hazardous substances and elements					
	鉛 Lead (Pb)	汞 Mercury (Hg)	鎘 Cadmium (Cd)	六价铬 Hexavalent Chromium (Cr(VI))	多溴联苯 Polybrominated biphenyls (PBB)	多溴二苯醚 Polybrominated diphenyl ethers (PBDE)
DA-3GHD-2x4	○	○	○	○	○	○
<p>O: Indicates that this toxic or hazardous substance contained in all of the homogeneous materials for this part is below the limit requirement in SJ/T11363-2006.</p> <p>X: Indicates that this toxic or hazardous substance contained in at least one of the homogeneous materials used for this part is above the limit requirement in SJ/T11363-2006.</p>						

This is indicated by the product marking:



A.2 Recycling information

Nevion provides assistance to customers and recyclers through our web site <http://www.nevion.com/>. Please contact Nevion’s Customer Support for assistance with recycling if this site does not show the information you require.

Where it is not possible to return the product to Nevion or its agents for recycling, the following general information may be of assistance:

- Before attempting disassembly, ensure the product is completely disconnected from power and signal connections.
- All major parts are marked or labeled to show their material content.
- Depending on the date of manufacture, this product may contain lead in solder.
- Some circuit boards may contain battery-backed memory devices.